

# HepcoMotion®

## **Shaft**

precision steel and  
aluminium shaft



# Introducing the HepcoMotion® Precision Shaft

Correct Shaft selection is vital if maximum performance is to be achieved from your linear system. Hepco Precision Shaft has been developed to provide excellent performance when used with Pacific liner technology, allowing optimal transfer of the Frelon material to the Shaft. Successful transfer in turn will provide a zero maintenance benefit as well as an extended life for users of Pacific linear/rotary bearings.

This precision hardened and ground Shaft is also the obvious choice for use with conventional recirculating linear bearing technology, offering excellent wear resistance.



## Shaft Options

Shaft Type Metric	REF	Hardness RC	TOL	Diameter Options											
				5	6	8	10	12	16	20	25	30	40	50	60
Metric Carbon Steel CK53 Hardened and Ground	NIM--	60	h6	√	√	√	√	√	√	√	√	√	√	√	√
Metric Stainless Steel (400 Series) Hardened and Ground	NIM--SS	50	h6	√	√	√	√	√	√	√	√	√	√	√	√
Metric Soft Stainless Steel (300 Series) Ground	NIM-- SS316	X	h6	√	√	√	√	√	√	√	√	√	√	√	√
Metric Hardcoat Anodised Aluminium	NIMA--	X	h6	-	-	√	√	√	√	√	√	-	-	-	-

Shaft Type Imperial	REF	Hardness RC	TOL	Diameter Options										
				3/16	1/4	3/8	1/2	5/8	3/4	1	1 1/4	1 1/2	2	
Imperial Carbon Steel CK53 Hardened and Ground	NIL	60	Class L	√	√	√	√	√	√	√	√	√	√	√
Imperial Stainless Steel (400 Series) Hardened and Ground	NIL--SS	50	Class L	√	√	√	√	√	√	√	√	√	√	√
Imperial Soft Stainless Steel (300 Series) Ground	NIL-- SS316	X	Class L	√	√	√	√	√	√	√	√	√	√	√
Imperial Hardcoat Anodised Aluminium	NILA--	X	Class L	√	√	√	√	√	√	√	√	√	√	√

Other types of shaft available include: • Specials up to 150mm Ø • Tubing Please enquire.

# Aluminium Shaft Supports

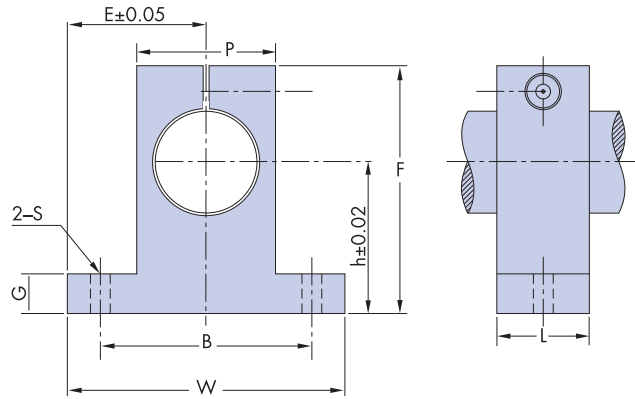

Nominal Shaft Diameter	Part No.	Major Dimensions									Mounting Bolt Designation	Weight g
		h	E	W	L	F	G	P	B	S		
10	ASS 10	17	18.5	37	10	30	5	18	28	4.5	M4	24
12	ASS 12	20	21	42	15	35	5.5	20	32	5.5	M5	30
16	ASS 16	25	25	50	15	42	6	26	40	5.5	M5	40
20	ASS 20	30	30	60	20	50	8	32	45	5.5	M5	70
25	ASS 25	35	37	74	25	58	9	38	60	6.6	M6	130
30	ASS 30	40	42	84	30	68	10	45	68	9	M8	180
40	ASS 40	50	54	108	30	86	12	56	86	11	M10	420
50	ASS 50	60	65	130	40	100	14	80	108	11	M10	750

Finish: Anodised

## Ordering Details

NIM--	_____	x	L _____	Metric hardened and ground carbon steel shaft
	Dia (mm)		(mm)	
NIM--SS	_____	x	L _____	Metric hardened and ground stainless steel shaft
	Dia (mm)		(mm)	
NIM--SS316	_____	x	L _____	Metric ground soft stainless steel shaft
	Dia (mm)		(mm)	
NIMA--	_____	x	L _____	Metric hardcoat anodised aluminium shaft
	Dia (mm)		(mm)	
NIL--	_____	x	L _____	Imperial hardened and ground carbon steel shaft
	Dia (ins)		(mm)	
NIL--SS	_____	x	L _____	Imperial hardened and ground stainless steel shaft
	Dia (ins)		(mm)	
NIL--SS316	_____	x	L _____	Imperial ground soft stainless steel shaft
	Dia (ins)		(mm)	
NILA--	_____	x	L _____	Imperial hardcoat anodised aluminium shaft
	Dia (ins)		(mm)	

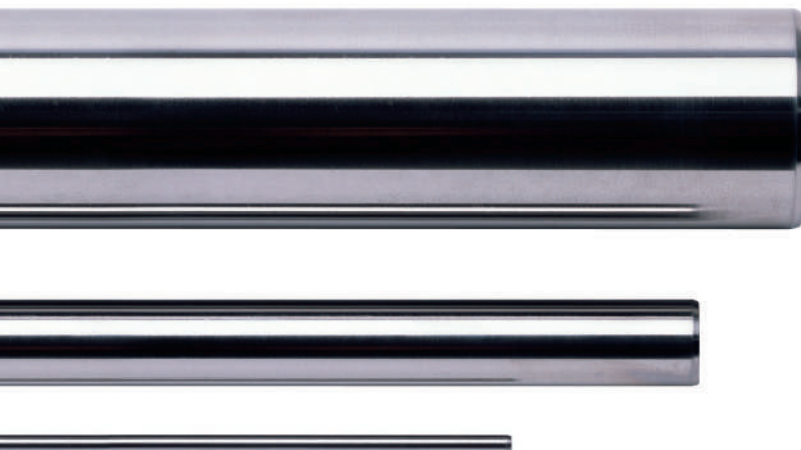

## Metric Shaft Support Rails

Shaft support rails will prevent shaft deflection under load and provide a high level of rigidity in order to achieve optimum performance from your open type Pacific Bearing, or any other open recirculating linear bearing.

Support Rails are of low overall height making them particularly suitable for use with Hepco Pacific Pillow Blocks. The standard support rail is manufactured from aluminium alloy and comes in 600mm lengths only, these are then cut/butted together to fit to the overall length of the one piece shaft.

Shaft – All types of shaft can be supplied drilled for customer assembly or fitted to the support rails for ease of supply.

For standard 600mm aluminium support rails, X = half of T1 or T2. For support rails which require cutting/butting, customer to confirm Dim X

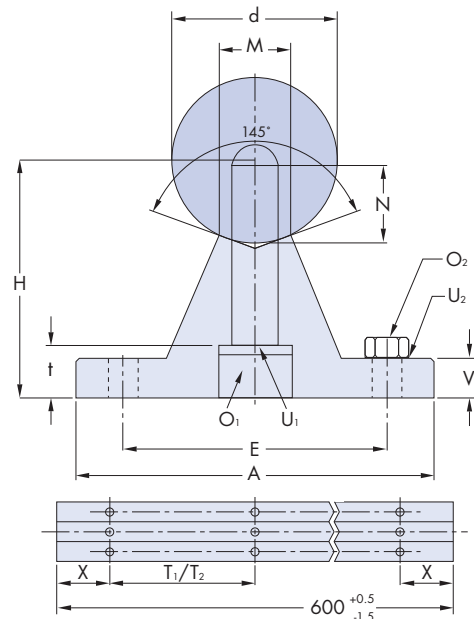

X = 1/2 hole pitch T<sub>1</sub> or T<sub>2</sub>

For Shaft Diameter	d	H <sub>1</sub> ±0.01	A	V	M	O <sub>1</sub>	U <sub>1</sub>	N	E	t	O <sub>2</sub> SQ.	U <sub>2</sub> DIN7980	T1	T2
12	12	22	40	5	5.8	M 4X20	4	8	29	4.5	M 4X12	4	75	120
16	16	26	45	5	7	M 5X20	5	9	33	7.6	M 5X16	5	100	150
20	20	32	52	6	8.3	M 6X25	6	11	37	8.6	M 6X16	6	100	150
25	25	36	57	6	10.8	M 8X30	8	15	42	9	M 6X16	6	120	200
30	30	42	69	7	11	M10X35	10	17	51	10	M 8X25	8	150	200
40	40	50	73	8	15	M10X40	10	19	55	9.5	M 8X25	8	200	300
50	50	60	84	9	19	M12X45	12	21	63	11.2	M10X30	10	200	300

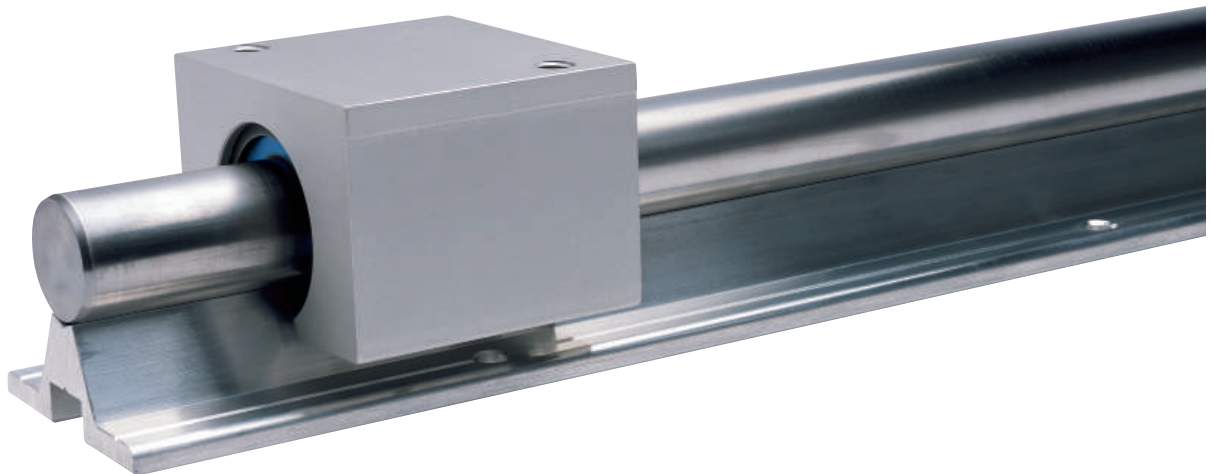

### Shaft & Support Rail Fully Assembled

Simply prefix the shaft reference with AU

Example – AU NIM 20 X L2000 T2

### Drilled Shaft Only

Simply state the shaft reference and add T1 or T2 depending upon shaft hole centres required

Example – NIM 20 X L2000 T2

### Support Rails Only

Aluminium Support Rails supplied in 600mm lengths only. Simply state whether T1 or T2 drilling is required

Example – Support Rail for 20mm Shaft T2  
Hole Centre – SR20 – T2

# Machined Ends Data Sheet

Hepco can machine all types of shaft to standard or special end configurations. This form can be used to fax us your requirements or alternatively you can send a drawing.

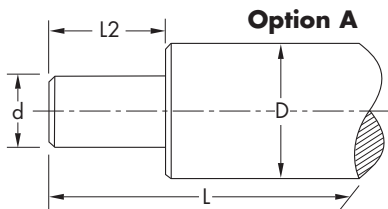

Spigot

One end  Both ends

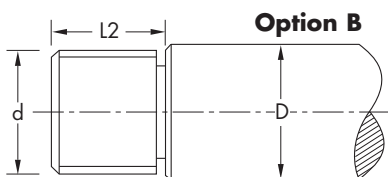

Undercut to DIN 76

Threaded Spigot

One end  Both ends

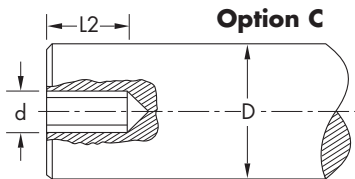

Drilled and Tapped

One end  Both ends

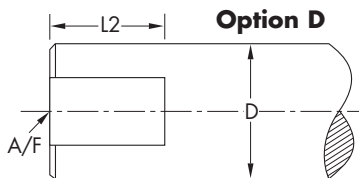

Single Flat  Double Flat

One end  Both ends

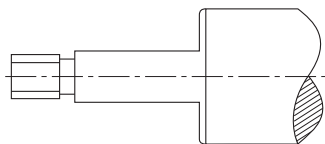

Please send drawing

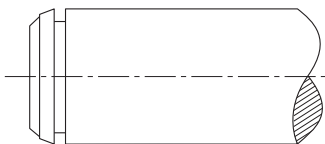

Please send drawing

Company	
Contact	
Address	
Post Code	
Phone	Fax
e-mail	

Dimensions – Option	L =	mm
D =	mm	d = mm/thread
L2 =	mm	A/F = mm

Material		
Hard Carbon Steel	CK 53	<input type="checkbox"/>
Hard Stainless Steel	400 series	<input type="checkbox"/>
Soft Stainless	300 series	<input type="checkbox"/>
Other		<input type="checkbox"/>
Solid		<input type="checkbox"/>
Tubing		<input type="checkbox"/>
Supported/Mounted		<input type="checkbox"/>
Quantity		

Sketch



# HepcoMotion® Product Range



**GV3**  
Linear Guidance and  
Transmission System



**HDS2**  
Heavy Duty  
Slide System

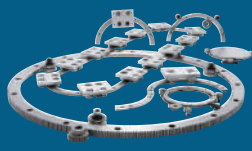

**PRT2**  
Ring Slides and  
Track System



**HDRT**  
Heavy Duty Ring Slides  
and Track System



**SL2**  
Stainless Steel Based  
Slide System

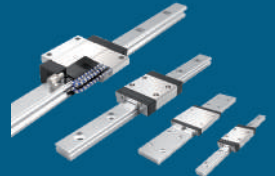

**HLG**  
Hepco  
Linear Ball Guides



**SBD**  
Sealed Belt  
Drive



**MCS**  
Aluminium Frame  
and Machine  
Construction System

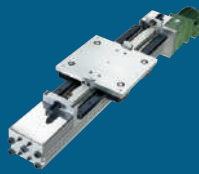

**HDLS**  
Heavy Duty Driven  
Linear System



**DLS**  
Linear Transmission and  
Positioning System

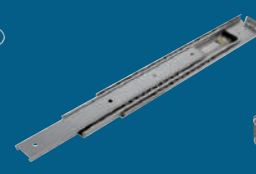

**HTS**  
Telescopic Ball  
Bearing Slides



**HPS**  
Powerslide-2 Guided  
Rodless Cylinder



**MHD**  
Heavy Duty Track Roller  
Guidance System

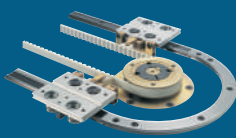

**DTS**  
Driven Track System



**BSP**  
Ballscrew Premier



**SimpleSelect®**  
Vee Slide Linear  
Guidance Systems

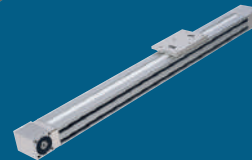

**PDU2**  
Profile Driven Unit

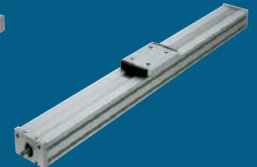

**PSD120**  
Profile Screw Driven Unit

## Bishop-Wisecarver Product Range

HepcoMotion® – Exclusive European partners and distributors for Bishop-Wisecarver since 1984.



**DUAL VEE®**  
Single Edge Slide System

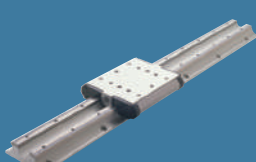

**LoPro®**  
Aluminium Based  
Slide System



**UtiliTrak®**  
Lightweight U Channel  
Guideway

For further information on HepcoMotion® products –  
please request our leaflet 'FPL'

**HepcoMotion®**  
[www.HepcoMotion.com](http://www.HepcoMotion.com)

Lower Moor Business Park, Tiverton Way, Tiverton, Devon, England EX16 6TG  
Tel: +44 (0)1884 257000 Fax: +44 (0)1884 243500  
E-mail: [sales@hepcotion.com](mailto:sales@hepcotion.com)

CATALOGUE No. Shaft 06 UK © 2016 Hepco Slide Systems Ltd.

Reproduction in whole or part without prior authorisation from Hepco is prohibited. Although every effort has been made to ensure the accuracy of the information in this catalogue, Hepco cannot accept liability for any omissions or errors. Hepco reserves the right to make alterations to the product resulting from technical developments.

Many Hepco products are protected by: Patents, Copyright, Design Right or Registered Design. Infringement is strictly prohibited and may be challenged in law. The Customer's attention is drawn to the following clause in Hepco's conditions of sale:

'It shall be the Customer's sole responsibility to ensure that goods supplied by Hepco will be suitable or fit for any particular application or purpose of the Customer, whether or not such application or purpose is known to Hepco. The Customer will be solely responsible for any errors in, or omissions from, any specifications or information the Customer provides. Hepco will not be obliged to verify whether any such specifications or information are correct or sufficient for any application or purpose.'

Hepco's full conditions of sale are available on request and will apply to all quotations and contracts for the supply of items detailed in this catalogue.

HepcoMotion is the trading name of Hepco Slide Systems Ltd.